

MJ 系列 使用說明書

目次

1. 安全注意事項
2. 安裝說明
3. 配結線與接地說明
4. 指撥開關設定
5. 控制面板操作說明
6. 故障碼表
7. 端子座

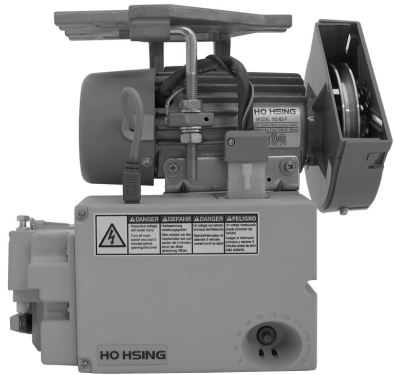

賀欣全球售服網
 服務專線：+886-2-2676-5203
 傳真：+886-2-2689-6600, 2689-3657
 電子郵件：service@hohsing.com.tw
 網址：http://www.hohsing.com

中國地區
 服務專線：+86-21-64901024
 傳真：+86-21-54570064
 網址：http://www.hohsing.com



HSPVMJU01-1 2009.03

MADE IN TAIWAN

EC 指令自我宣告書：

本公司在此宣告以下產品系列：
 AC 伺服馬達-MJ 系列

皆符合以下 EC 指令的規定：
 -EC 低電壓指令 (73/23/EEC)
 -EC 電磁兼容指令(89/336/EEC)
 -EC 機械指令 (98/37/EC)

及配合相關安全標準如下：
 EN 60204-31：機械之電機設備之安全。
 EN 292-1：機械安全-基本概念、設計的一般原則。
 EN 292-2：機械安全-技術指導及規格設計原則。
 EN 61000-6-2：EMS 電磁耐壓防護-工業區。
 EN 61000-6-3：EMI 電磁干擾防護-住宅區。

有毒物質限量指令自我宣告書：

本公司在此宣告以下產品系列：
 AC 伺服馬達-MJ 系列

皆符合以下指令的規定：
 1. 歐盟 RoHS 指令 (2002/95/EC)
 2. 中華人民共和國電子行業標準：電子信息產品中有毒有害物質的限量要求 (SJ/T 11363-2006)

本公司產品本身(馬達、控制箱)或其包裝材料及附件(紙箱、螺絲配件包、說明書、貼紙、標籤、印刷品...等等)或其元件與原材供應廠商皆依照歐盟 RoHS 指令及中華人民共和國電子行業標準的限量規定而符合以下所列之六種有害物質的限量要求：

有毒物質	限量要求
鉛 (Pb)	低於 240 ppm
汞 (Hg)	低於 800 ppm
鎘 (Cd)	低於 80 ppm
六價鉻 (Cr VI)	低於 800 ppm
多溴聯苯 (PBB)	低於 800 ppm
多溴二苯醚 (PBDE)	低於 800 ppm

* 基板的無鉛製程：總鉛含有濃度基準量 800 ppm 以下。
 * 包裝材料：Pb+Hg+Cd+Cr VI 含有濃度基準量 共合計 80 ppm 以下。

賀欣機械廠股份有限公司

廠長
 李春長先生

1. 安全注意事項：

使用前請詳閱本手冊與所搭配的縫紉機說明書，並請注意下列事項

- 安裝及操作須由受過正確訓練的人員來執行，拆卸安裝動作前請先關閉電源拔掉插頭並等待 5 分鐘。
- 本驅動裝置僅適用於指定範圍的縫製機械，請勿移做其他用途。
- 電源電壓請遵照 MJ 馬達與控制箱銘牌所標示之規格 ±10 % 範圍內操作。

※注意：控制箱電源規格如為 AC 220V 時，請勿插接到 AC 380V 的電源插座上，否則將出現異常且面板指示燈會持續閃爍警示，此時請立即關閉電源開關，重新檢查電源，持續供應 380V 超過五分鐘以上，將可能燒損主基板上的保險絲和電解電容或可能危及人身安全。

- 請遠離高週磁波機器或電波發射器等，以免所產生的電磁波干擾本驅動裝置因而發生誤動作。
- 請不要在日光直接照射的場所、室外及室溫 45°C 以上或 5°C 以下的場所操作。
- 請不要在暖氣(電熱器)旁、有露水的場所及在相對濕度 30 % 以下或 95 % 以上的場所操作。
- 請不要在灰塵多的場所、具有腐蝕性物質的場所及有揮發性氣體的場所操作。
- 請注意不要被物壓住或過度扭曲電源線。
- 裝釘電源線時請不要靠近會轉動的皮帶輪及三角皮帶，最少要離開 3 公分以上。
- 為防止雜訊干擾或漏電事故，請做好接地工程。
- 在第一次開電後，請先以低速操作縫紉機並檢查轉動方向是否正確。
- 縫紉機運轉時，請不要去觸摸皮帶輪、三角皮帶、天秤、針等會動作的部位。
- 所有可動作的部份，必須以所提供的防護裝置加以隔離，防止身體接觸並請勿在裝置內塞入其他物品。
- 修理及保養須由經過訓練的技術人員執行，而所有維修用的零件須由本公司提供或認可，方可使用。
- 請不要以不適當物體來敲擊或撞擊本產品裝置。

危險標示 - 注意標示

這個標示符號表示機器安裝時，如有錯誤恐會傷害到人體或機器會受到損壞，所以機器方面有危險性的地方會有此標示。

這個標示符號表示有高壓電，電氣方面有危險性的地方會有此標示。

保固期限

本產品保固期限為購買日期起一年內或出廠月份起 18 個月內。

保固內容

本產品在正常情況且無人為失誤的操作下，於保固期間無償的為客戶維修使能正常操作，但以下情況於保固期間將得以收取維修費用：

1. 不當使用包括錯誤接高壓電源、將產品移做其它用途、自行拆卸、維修、更改、或不依規格範圍使用、進水進油及插入異物於本產品。
2. 火災、地震、閃電、風災、水災、鹽蝕、潮濕、異常電壓及其它天災或不當場所造成之損害。
3. 客戶購買後摔落本產品，或客戶自行運輸(或託付之運輸公司)所造成之損害。

*本產品於生產及測試上皆盡最大努力和嚴格控管使其達到高品質及高穩定的標準，但外部之電磁或靜電干擾或不穩定的供應電源，仍可能對本產品造成影響或損害，因此操作場所的接地系統一定要確實做好，並建議客戶安裝故障安全防護裝置(如漏電電驛)。

2. 安裝說明：

MJ 系列的安裝方式

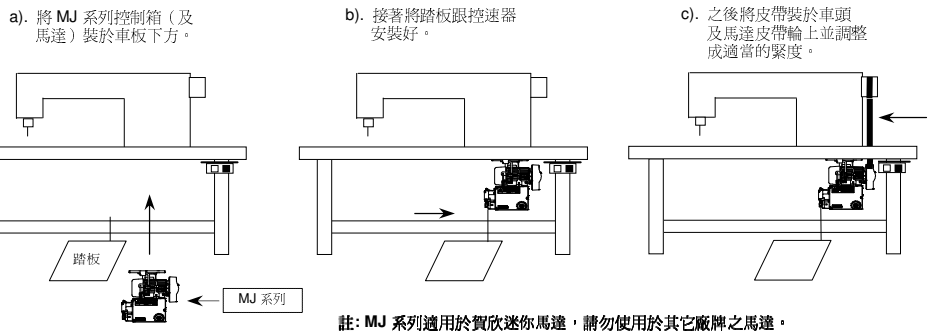

註：MJ 系列適用於賀欣迷你馬達，請勿使用於其它廠牌之馬達。(直驅馬達於出廠時皆已安裝好於車頭上，如有必要重新安裝或拆卸，請依據車頭說明書中指示。)

定位器的安裝

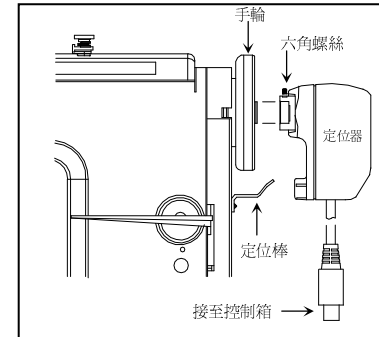

將定位器安裝於手輪心軸突出處並將定位器底部凹槽對準車頭上的定位棒，位置調整好後將定位器轉子上的兩顆六角螺絲鎖好，最後將定位器插頭接至控制箱的定位器插座。
 註：定位棒型式及安裝位置會因車頭機型而有所不同。

注意：
 安裝及調整前請確定已關掉電源開關及拔掉插頭以利人身安全。

定位器的調整 (請先打開定位器上蓋)

針上位置設定：用手轉動車頭皮帶輪，使天桿停在最高點位置或車頭指定之上停針位置點，再將上定位感應片(A)的紅點對準底座的基準紅點。
 針下位置設定：用手轉動車頭皮帶輪，使針停在最低點位置或車頭指定之下停針位置點，再將下定位感應片(B)的藍點對準底座的基準紅點。
 註：上述調整為標準調法，如覺得定位不準，可自行進行微調。

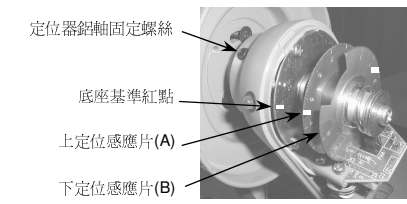

控速器的調整

注意：
 調整前請確定已關掉電源開關及拔掉插頭以利人身安全。

控速器各部位名稱：如圖示
 A：前踏力量彈簧。
 B：後踏力量的調整螺絲。
 C：踏板旋臂。
 D：腳踏吊桿。

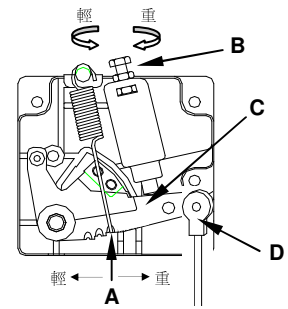

調整需求	調整結果
1 踏板前踏力量的調整	當彈簧 A 愈向右側勾時，表示力量的愈重。 當彈簧 A 愈向左側勾時，表示力量的愈輕。
2 踏板後踏力量的調整	當螺絲 B 愈向上時，則後踏力量愈輕。 當螺絲 B 愈向下時，則後踏力量愈重。
3 踏板行程長短的調整	當吊桿 D 向右侧孔鎖裝時，表示行程較長。 當吊桿 D 向左侧孔鎖裝時，表示行程較短。

3. 配結線與接地說明：

單相接線(AC220V)

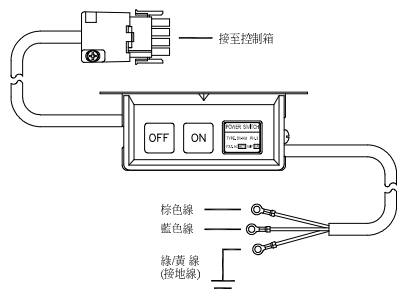

注意：綠/黃色電線為接地線，一定要做好系統的接地工程。

當有多台單相 220 V 伺服馬達欲同時安裝在三相供電線路上時，須注意 R,S,T 各相負載平衡，如下圖所示：

三相 220V 供電線路：

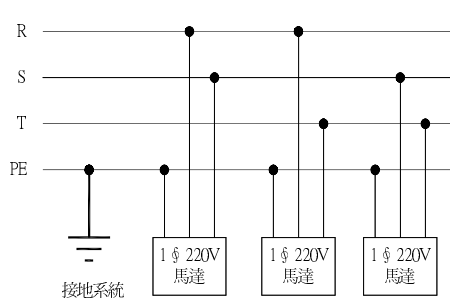

三相 380V 供電線路：

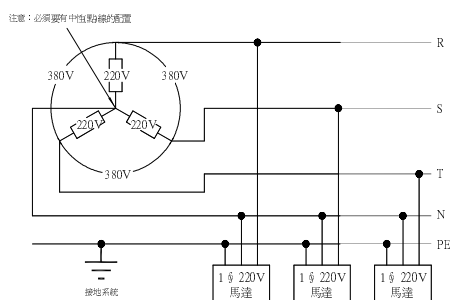

注意：如果此配置系統沒有【中性(點)線】時，則單相 220V 的伺服馬達不適合在此場所使用，請向原供應商改訂購本廠牌之三相 380V 的伺服馬達機型。

4. 指撥開關設定：

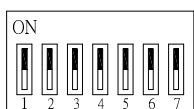

編號	功能名稱	功能敘述
1	VDN：定位器型式	ON：單訊號 OFF：雙訊號
2	TRM：切線模式	ON：繃縫機 OFF：平縫機
3-4	SP1 - SP0：馬達最高回轉數	ON - ON：4500rpm ON - OFF：3500rpm OFF - ON：2500rpm OFF - OFF：1800rpm
5	DIR：馬達回轉方向	ON：反轉 (CW) OFF：正轉 (CCW)
6	NUD：針定位	ON：針上定位 OFF：針下定位
7	SS：緩起動	ON：緩起動有效 OFF：緩起動無效

5. 控制面板說明：

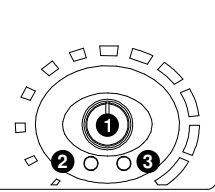

面板功能：

- 1 車縫速度調整旋鈕
旋鈕逆時針調，速度減慢 / 旋鈕順時針調，速度加快。
- 2 電源指示燈
開啓電源後，LED 燈亮 / 關閉電源後，LED 燈熄。
- 3 定位器指示燈 / 故障警示燈
定位器模式：LED 燈熄=使用定位器，LED 燈亮=未使用定位器。
故障警示：控制箱異常時警示閃爍，請參考故障碼表。

6. 故障碼表：

故障碼及排除對策：

1. 當 MJ 系列控制箱若有故障或錯誤異常狀況發生時，故障訊息將由控制面板上的 LED 故障警示燈做閃爍警示。(如下圖)
2. 故障排除修理及保養維護須由經過訓練的技術人員執行。

面板 LED 指示燈閃爍顯示	故障碼警示	出現時機	狀態與對策
閃爍 4 次 暫停 1 秒	ERO. 4	1. 電源 ON 時，檢知到電源電壓過高。 2. 插錯使用之供應電源。 3. 煞車用鋁殼電阻發生異常。	馬達與車頭出力將全部關閉成無動作狀態。 請檢查供應此控制箱之 AC 電源是否正確。 請仔細檢查電源板。 請檢查控制箱內鋁殼水泥電阻是否正常。
閃爍 7 次 暫停 1 秒	ERO. 7	1. 馬達插頭插線接觸不良導致不轉。 2. 定位器信號異常。 3. 車頭機構鎖住或馬達皮帶輪異物捲入卡住。 4. 加工物過厚，馬達扭力不足無法貫穿。	馬達與車頭出力將全部關閉成無動作狀態。 請檢查馬達本身或馬達插頭插線等信號是否異常。 請檢查定位器信號是否異常。 請檢查車頭是否卡住或干擾轉動困難。

7. 端子座圖：

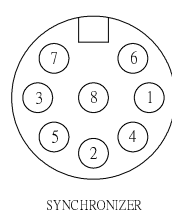

SYNCHRONIZER	
1	---
2	+5V
3	DOWN
4	0V
5	NO SYNC.
6	---
7	UP
8	---

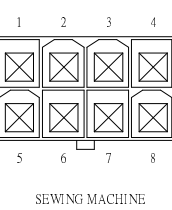

SEWING MACHINE	
1	ML SOL. (AIR)
5	+30V
2	APL SOL. (AIR)
6	+30V
3	NCL SOL. (AIR)
7	+30V
4	TRIMMER SOL. (MAGNETIC)
8	+30V

如果您有任何其它技術上的問題，請連絡經銷商服務人員或瀏覽本公司網頁 <http://www.hohsing.com> 尋求技術支援。

MJ SERIES USER MANUAL

CONTENTS

1. Safety Precaution
2. Installation
3. Wiring and Grounding
4. DIP-SWITCH Adjustment
5. Control Panel
6. Error Code List
7. Connector Panel

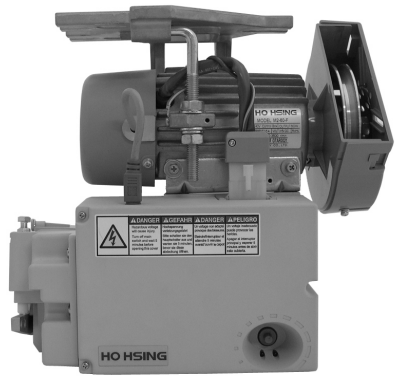

H. S. Global Service Network
 SERVICE HOTLINE : +886-2-2676-5203
 FAX : +886-2-2689-6600, 2689-3657
 E-MAIL: service@hohsing.com.tw
 WEBSITE: http://www.hohsing.com

China Region
 SERVICE HOTLINE : +86-21-64901024
 FAX : +86-21-54570064
 WEBSITE : http://www.hohsing.com



HSVPMJU01-1 2009.03

EC Declaration of Conformity

We hereby declare that the following products:
 AC servo motor-MJ series
 are in conformity with the provision of the EC directives as following:
 -EC Low Voltage Directive (73/23/EEC)
 -EC Electromagnetic Compatibility Directive (89/336/EEC)
 -EC Machinery Directive (88/37/EEC)
 Applied harmonized standards:
 EN 60204-3-1: Electrical equipment of industrial machines. Particular requirements for sewing machines. Particular requirements for sewing machines, sewing units and sewing system.
 EN 292-1: Safety of machines. Technical guidelines and specifications.
 EN 61000-6-2: EMS for industrial environment.
 EN 61000-6-3: EMI for residential environment.

Declaration of Conformity for Concentration Limits for Certain Hazardous Substances

We hereby declare that the following products:
 AC servo motor-MJ series
 are in conformity with the following directives and requirements:
 1. European Union RoHS Directive (2002/95/EC) and the concentration limits for certain hazardous substances (2005/618/EC)
 2. People's Republic of China Electronic Business Standard: Requirements for concentration limits for certain hazardous substances in electronic information products (SJ/T 11363-2006)
 Our product itself (motor, control box) or its packing materials and accessories (box, screws package, user manual, sticker, label, print, etc.) or the suppliers of parts and raw materials are all in conformity with the provision of the European Union RoHS Directive and People's Republic of China Electronic Business Standard to conform the following concentration limits for the six hazardous substances:

Hazardous Substance	Permissible Values
Lead (Pb)	Less than 240 ppm
Mercury (Hg)	Less than 800 ppm
Cadmium (Cd)	Less than 80 ppm
Hexavalent chromium (Cr VI)	Less than 800 ppm
Polybrominated Biphenyl (PBB)	Less than 800 ppm
Polybrominated Diphenyl ether (PBDE)	Less than 800 ppm

* The concentration of lead in the lead-free process for PCB shall be less than 800 ppm.
 * For packing materials shipped with our products or parts, the hazardous substances shall be 80 ppm or less in sum of Pb+Hg+Cd+Cr VI.

H. S. Machinery. Co., Ltd.

Mr. C. C. Lee
 Plant Manager

1. Safety Precaution :

Please read this manual with sewing machine manual thoroughly and pay attention for the following safety precaution.

- Installation and operation must be done by the trained personnel, also turn off the power switch and remove the plug from outlet and wait for 5 minutes before any installation.
- This product is designed for the specific sewing machines and must not be used for other purposes.
- Only use the power voltage as described on the name plate of the MJ motor and control box in $\pm 10\%$ ranges.
- ✘ **Attention : If the control box is AC 220V system, please don't connect to the AC 380V power outlet, otherwise the error will occur and panel LED will blink continually. If that happened, please turn off the power switch immediately and check the power voltage. Continue supply the 380V power over 5 minutes might damage the fuses (F2,F3) of main board and burst the electrolytic capacitors (C4,C5) of main board and even might endanger the person safety.**

- In order to prevent abnormal operation, keep the product away from the high frequency machines.
- Don't operate in direct sun light - outdoors area and the room temperature is 45°C above or 5°C under.
- Don't operate near the heater - dew area and the humidity is 30% less or 95% more.
- Don't operate in dusty - evaporate - combustible gas area, and stay away from corrosive material.
- Don't apply heavy objects or excessive force on the power cord, also don't bend or pull the power cord.
- Power cord must keep 3 cm or above distance away from the V-belt and the pulley.
- In order to prevent the static interference and current leakage, all grounding works must be done properly.
- After power on the machine for the first time, use low speed to operate and check the correct rotation direction.
- During machine operation, don't touch any moving parts.
- All moving parts must have protective device to avoid the body contact and objects insertion.
- Maintenance and repair must be done by the properly trained technician, also all the spare parts for repair must be approved or supplied by the manufacturer.
- Don't use any objects or force to hit or ram the product.

Danger and caution signs

- Risks that may cause personal injury or risk to the machine are marked with this symbol in the instruction manual.
- This symbol indicates electrical risks and warnings.

Limited Warranty

Warranty period of this product is 1 year from purchasing, or 18 months from our manufacturing date.

Warranty Detail

Any trouble found within warranty period under normal use condition in conformance with this manual, it will be repaired free of charge. Repair will be chargeable in the following cases even if within warranty period.

1. Inappropriate use include: wrong connecting high voltage, wrong application, disassemble, repair, modification by incompetent personnel, or operate the product without the precaution, or operate the products out of its specification range. Insert odd objects or liquids into the product.
2. Damage by fire, Earth quake, lightning, wind, flood, salt corrosive, moisture, abnormal power voltage and any other damage cause by the natural disaster or by the inappropriate environments.
3. Dropping after purchase, or damage in transportation by customer himself. (or by customer's shipping agency)

Note : We put our best effort and mind in testing and manufacturing for assuring the quality and reliable of this product. But it is possible this product can still be damaged due to external magnetic interference and electronic static or noise or unstable power source more than expected; therefore the grounding system of operate area must be well-connected to this product and it's also recommended to install a failsafe device. (such as residual current breaker).

2. Installation :

MJ installation

- Install the MJ series control box (and motor) under the table.
- Install the pedal with speed control unit.
- Install the V-Belt on the motor and machine pulley then adjust the belt to its appropriate tension.

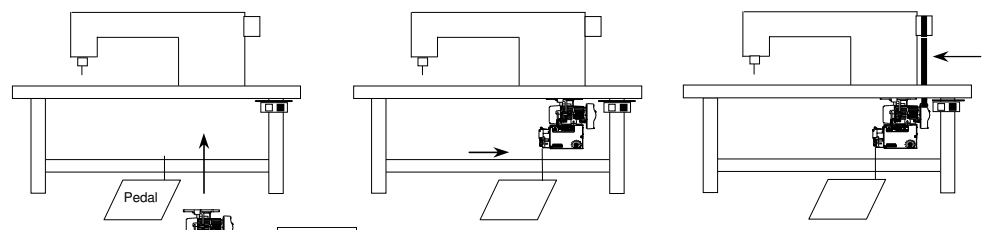

Note: MJ series is designed for the H. S. mini motor, don't use with other brand of motor.(direct-drive motor is pre-installed on the machine head, if reinstall or disassembly is necessary, please refer to the sewing machine user manual.)

Synchronizer installation

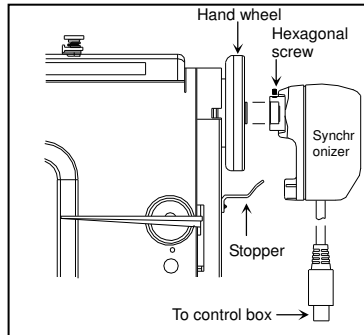

Mounting the Synchronizer onto the flange of hand wheel and match the stop groove of the synchronizer with the stopper of the machine head then tighten and secure 2 hexagonal screws of the synchronizer rotor, then connect the synchronizer cable to the control box.
 Note : Stopper type and location might be varied, depend by the machine model.

Caution :
 For person safety, turn off the power switch and remove the power plug from outlet before any adjustment.

Synchronizer Adjustment (Please open the top cover first)

- Needle up position : Rotate the machine pulley to reach mechanical needle up position and turn the photo disc (A) until its red mark is aligned with the red mark on the bearing cover plate.
 - Needle down position : Rotate the machine pulley to reach mechanical needle down position and turn the photo disc (B) until its blue mark is aligned with the red mark on the bearing cover plate.
- Note: Instruction above is the standard adjustment. If you feel the position wasn't accurate, please do the fine tuning by yourself.

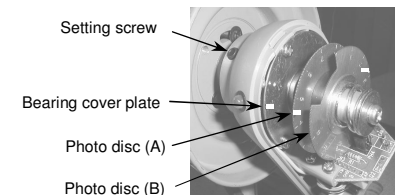

Speed control unit adjustment



Caution :
 For person safety, turn off the power switch and remove the power plug from outlet before any adjustment.

Components of speed control unit : see figure

- A : Spring for toeing forward force adjustment
- B : Bolt for heeling backward force adjustment
- C : Pedal arm
- D : Pitman rod for pedal

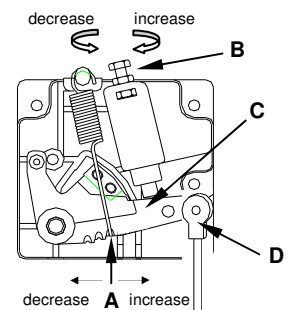

	Term of adjustment	Adjustment result
1	Toeing forward force adjustment	Spring A move to right = force increased Spring A move to left = force decreased
	Heeling backward force adjustment	Bolt B turn = force decreased Bolt B turn = force increased
3	Pedal stroke adjustment	Rod D secure at right = stroke is longer Rod D secure at left = stroke is shorter

3. Wiring and Grounding :

Single phase (AC220V)

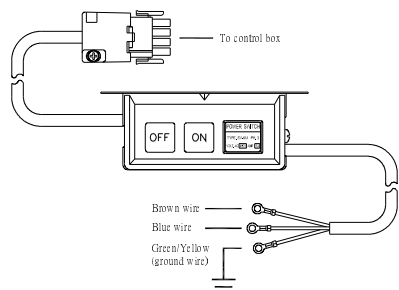

Caution :
 Green / yellow wire is for ground, and all grounding works must be done properly.

When multiple 1Φ / 220 V motors are connected to a power source, take caution for the load balance of each R, S, T phase, see the following diagram :

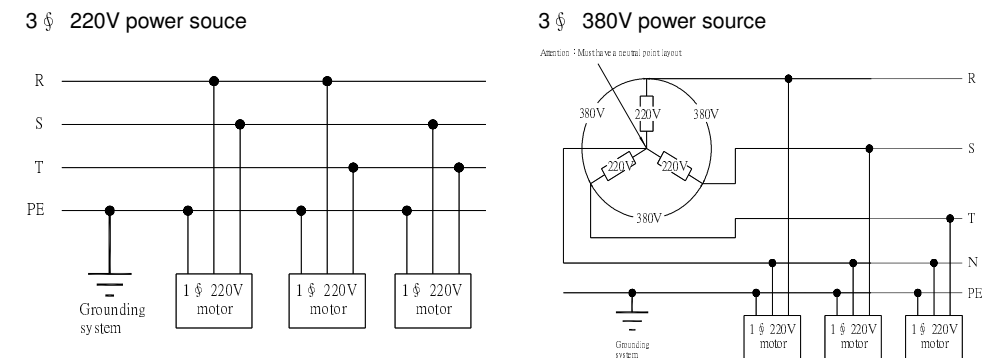

Caution : If the power source does not have the neutral point, then this 1Φ / 220 V servo motor is not suitable for this connection. Please ask supplier to offer our 3Φ / 380 V servo motor.

4. DIP-SWITCH Adjustment :

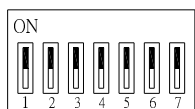

No.	Function Name	Description
1	VDN : Synchronizer Type	ON : Single signal OFF : Two signals
2	TRM : Trimming Mode	ON : For general Cover-Stitch machines OFF : For general Lock-Stitch machines
3 - 4	SP1 · SP0 : Motor Max. Speed	ON · ON : 4500 rpm ON · OFF : 3500 rpm OFF · ON : 2500 rpm OFF · OFF : 1800 rpm
5	DIR : Direction of motor rotation	ON : clockwise OFF : counterclockwise
6	NUD : Positioning Mode	ON : Needle up OFF : Needle down
7	SS : Slow start	ON : Valid OFF : Invalid

5. Control Panel :

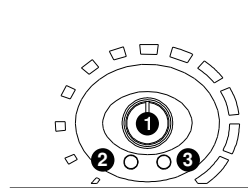

Control panel key functions :

- 1 Sewing speed adjust knob**
 Knob turn counterclockwise : speed down.
 Knob turn clockwise : speed up.
- 2 Power ON LED**
 Power ON, LED ON.
 Power OFF, LED OFF.
- 3 Synchronizer indicator / Error code indicator**
 Synchronizer mode : LED OFF=use synchronizer.
 LED ON =without synchronizer.
 Error warning : when this LED blinking, see the error code list.

6. Error Code List :

Panel LED for error code :

1. When MJ control box is malfunction or abnormal, the error message will be warned by the blinking of 2 LED on the control panel. (See the following list)
2. Repair and maintenance must be performed by the properly trained technician.

Panel LED blinking	Error code	Cause of the problem	Condition and solution
Led blinking 4 times every cycle	ER0. 4	1. When power on, higher power voltage has been detected. 2. Connect to a wrong AC power source. 3. Aluminum casing resistor for the brake circuit is defective.	Motor and machine will be shutting down. Please check the AC power source. Please check the power board. Please check the aluminum casing resistor.
Led blinking 7 times every cycle	ER0. 7	1. Bad connection to the motor connector. 2. Synchronizer (sensor) signal error. 3. Machine locked or object stuck in the motor pulley. 4. Sewing material is too thick.	Motor and machine will be shutting down. Please check the motor or motor connectors' connection. Please check the synchronizer (sensor) and its signal. Please check machine head to see if any objects stuck in the motor pulley, or machine does not rotate smoothly.

7. Connector Panel :

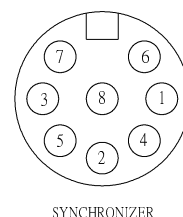

SYNCHRONIZER	
1	---
2	+5V
3	DOWN
4	0V
5	NO SYNC.
6	---
7	UP
8	---

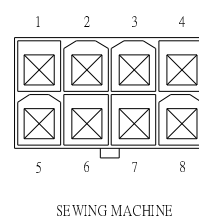

SEWING MACHINE	
1	ML SOL. (AIR)
5	+30V
2	AFL SOL. (AIR)
6	+30V
3	NCL SOL. (AIR)
7	+30V
4	TRIMMER SOL. (MAGNETIC)
8	+30V

If you need the technical support, please contact your distributor or browse our website at <http://www.hohsing.com>